

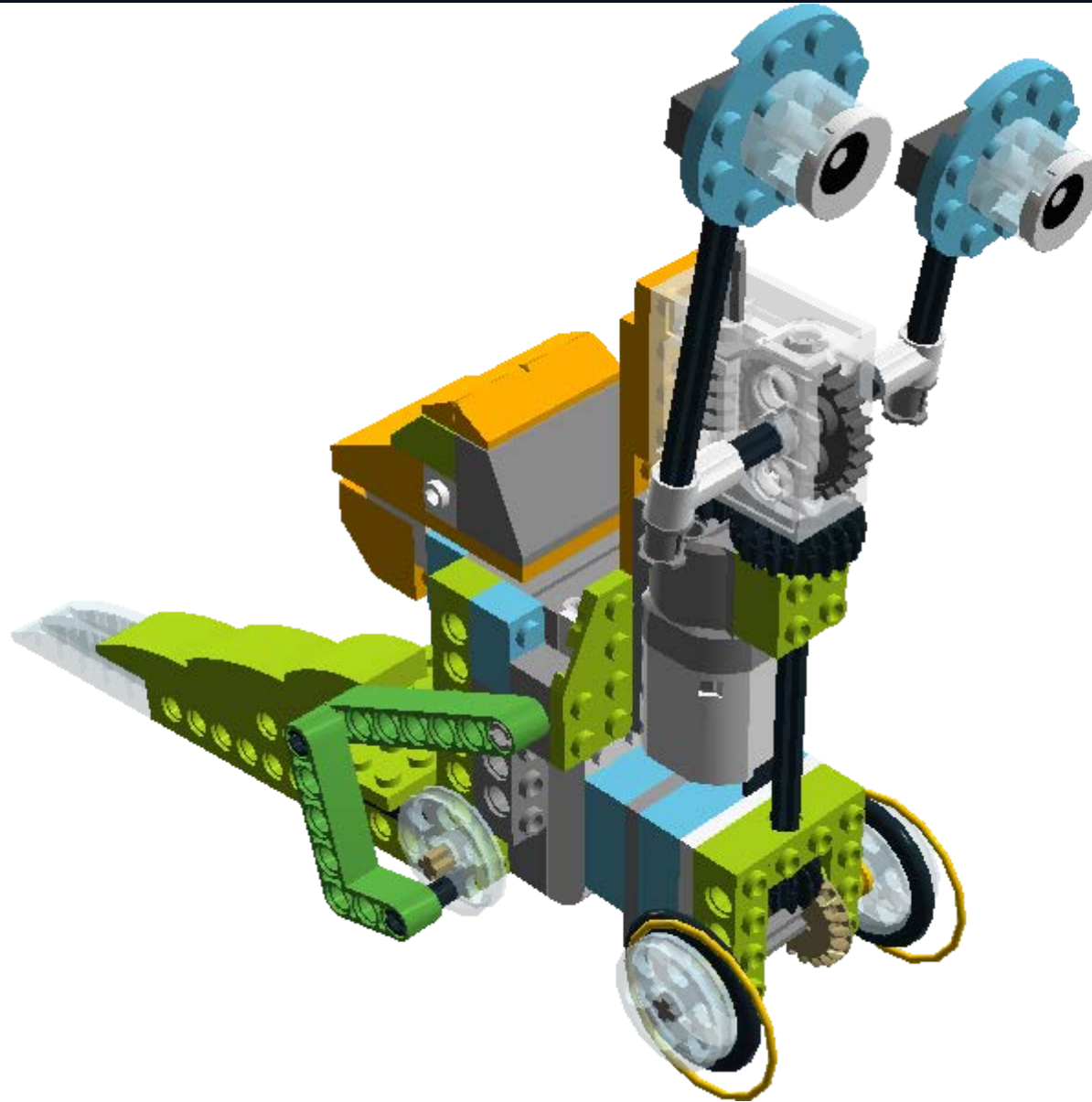

# DIGITAL DESIGNER 4.2

Model Name:  
**Snail**

Number of Bricks: **121**



**Step 1 of 42**

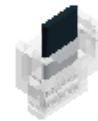
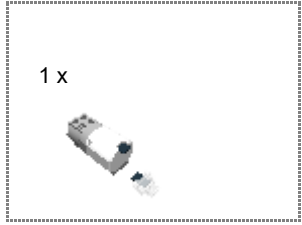

**Step 2 of 42**

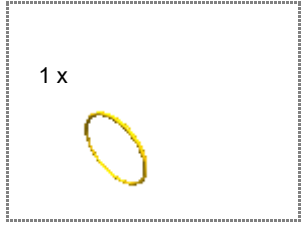

**Step 3 of 42**

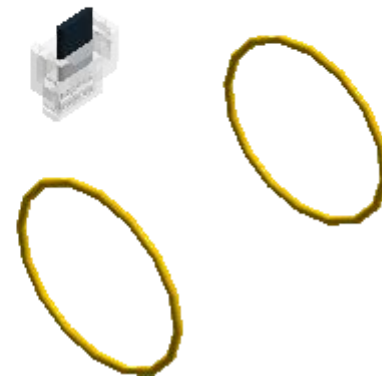
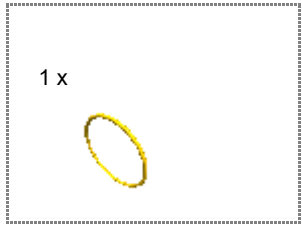

Step 4 of 42

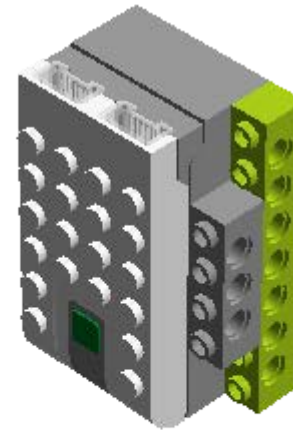
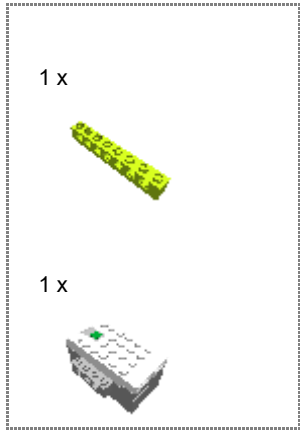

Step 5 of 42

1 x

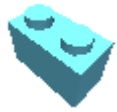

1 x



1 x

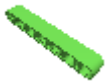

1 x

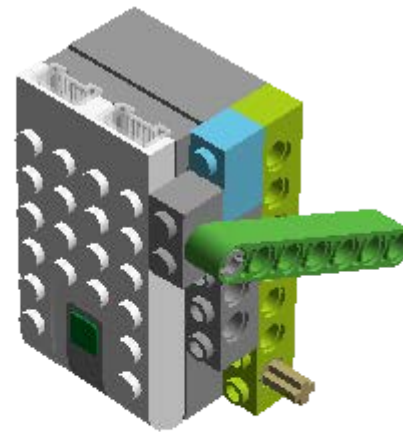

Step 6 of 42

1 x



1 x



2 x

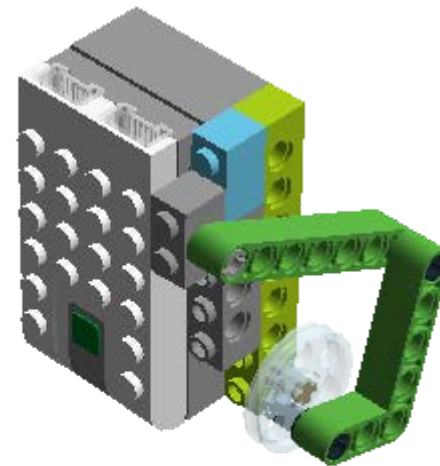

Step 7 of 42

1 x

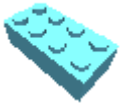

1 x



1 x



1 x

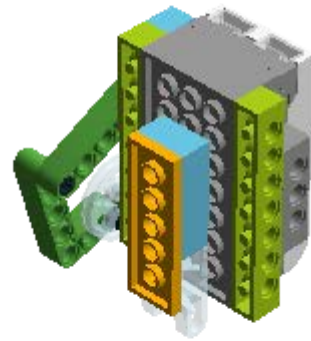



Step 8 of 42

1 x

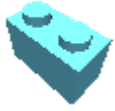

1 x



1 x



1 x

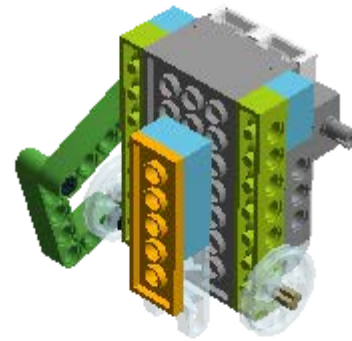

Step 9 of 42

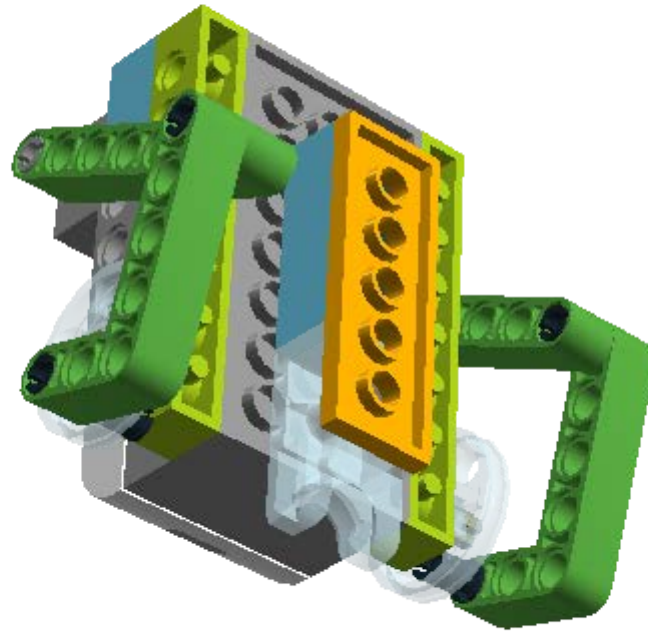
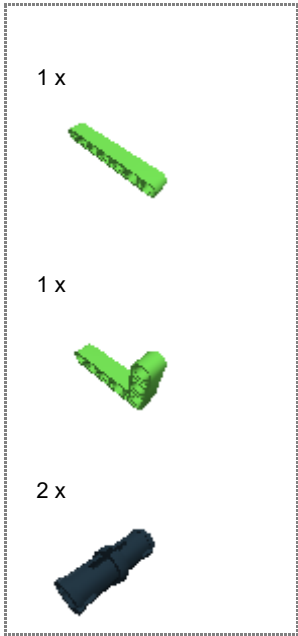

Step 10 of 42

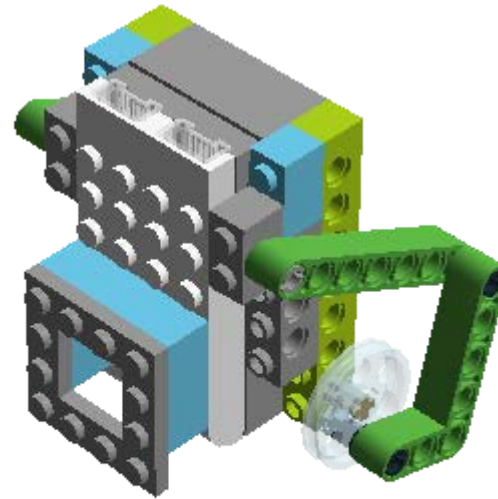
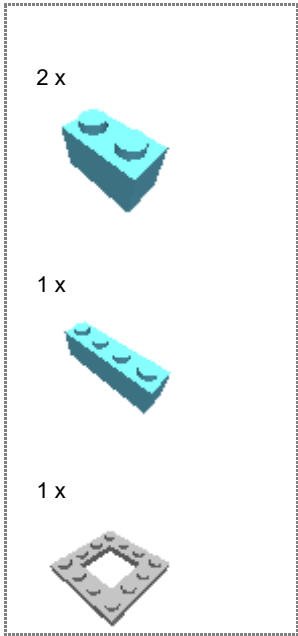

Step 11 of 42

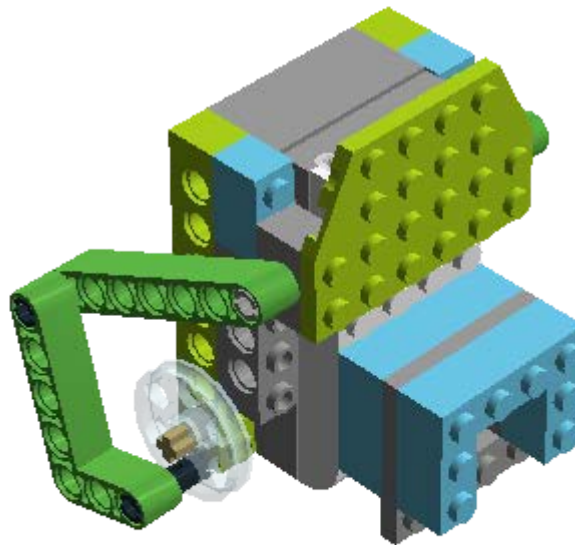
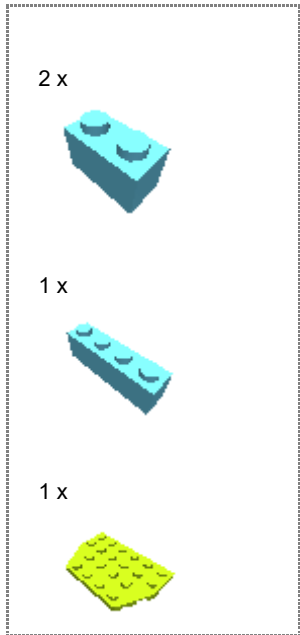

Step 12 of 42

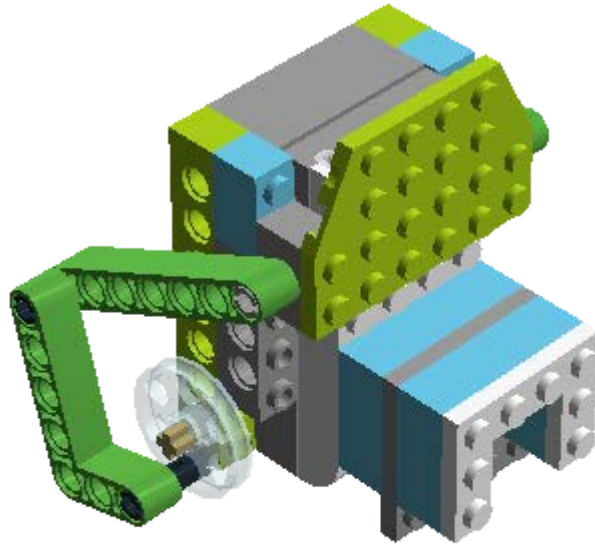
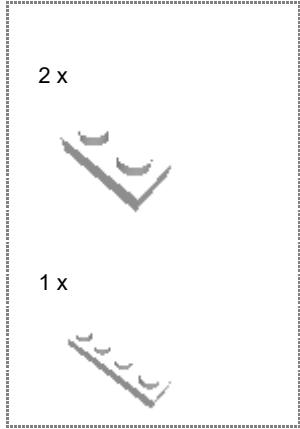

Step 13 of 42



Step 14 of 42

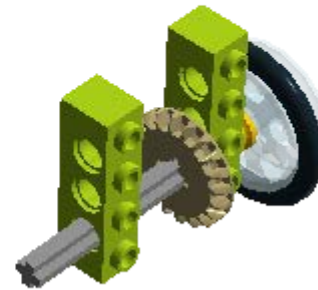
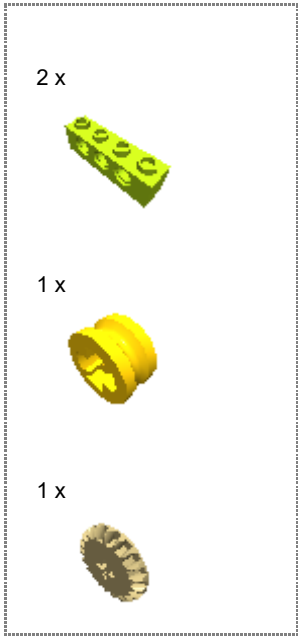

Step 15 of 42





**Step 16 of 42**

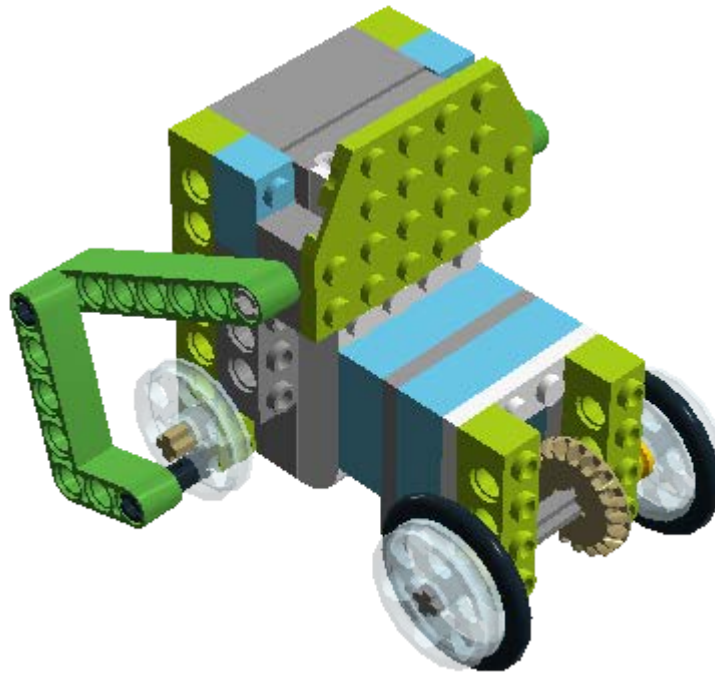

Step 17 of 42

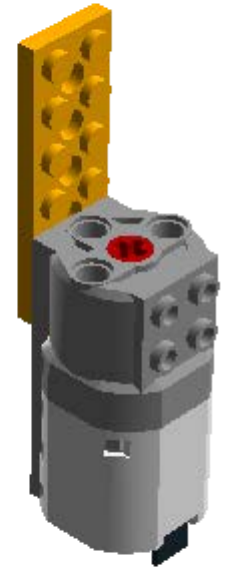
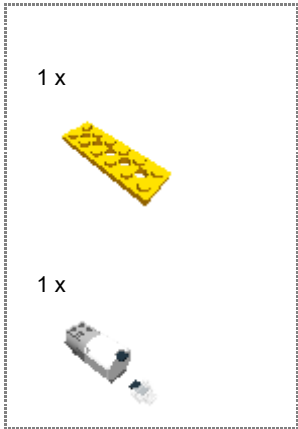

Step 18 of 42

1 x



1 x



1 x



1 x

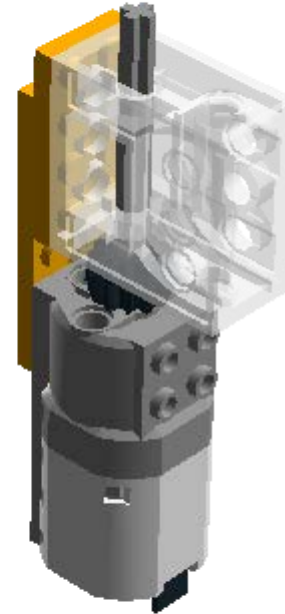

**Step 19 of 42**

1 x



Step 20 of 42

1 x



1 x



1 x



1 x

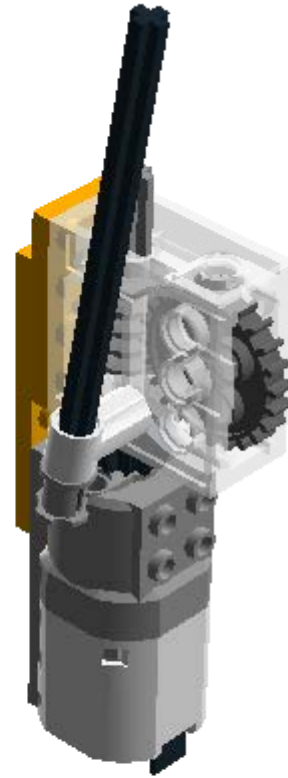

Step 21 of 42

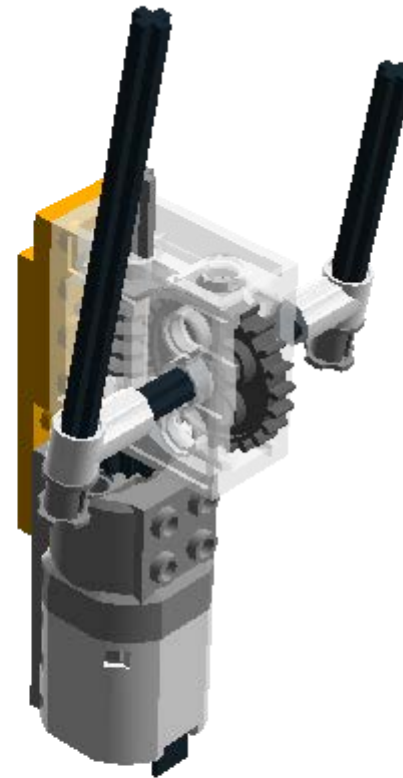
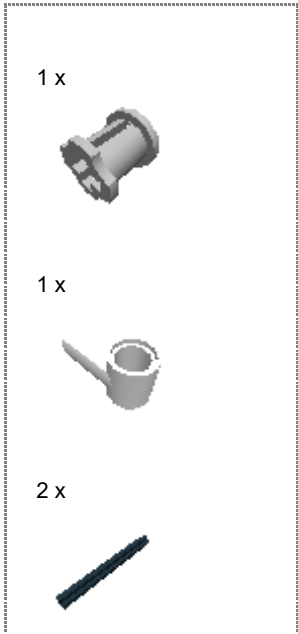

Step 22 of 42

1 x



1 x



1 x



1 x

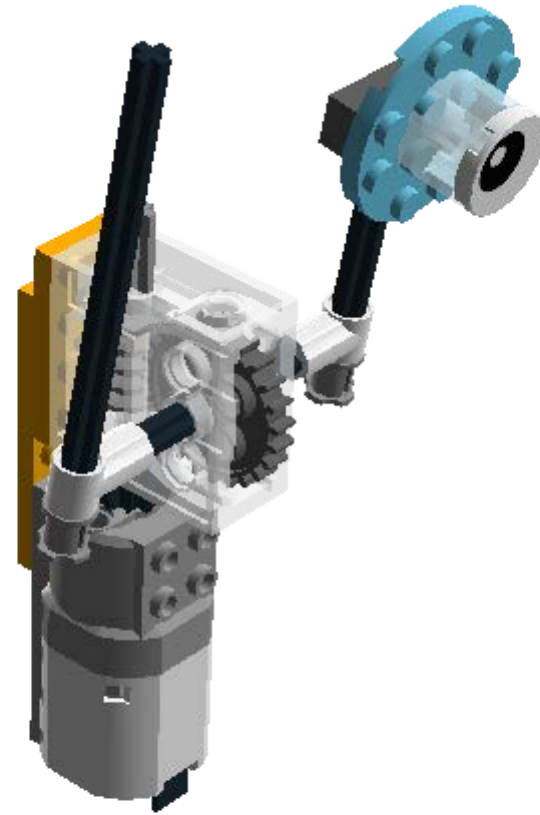

Step 23 of 42

1 x



1 x



1 x



1 x





Step 24 of 42

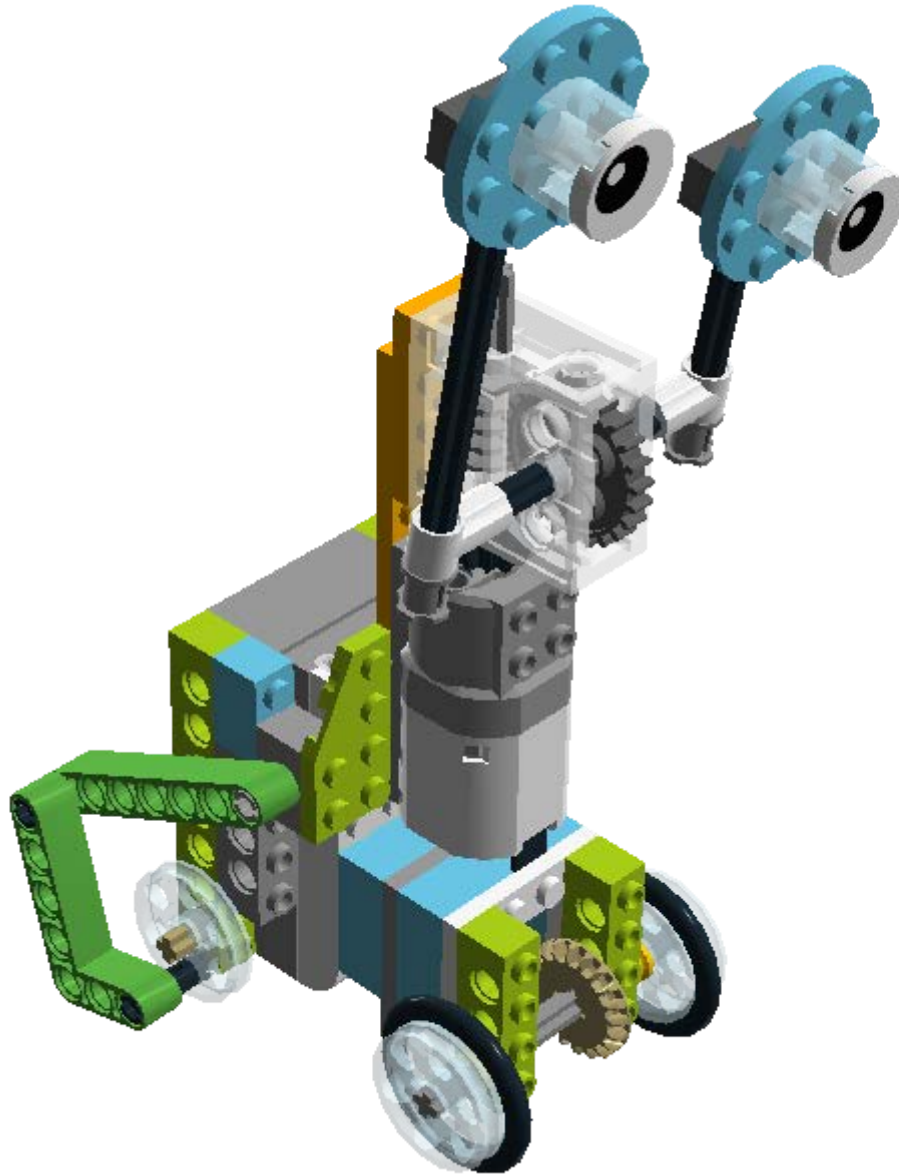

Step 25 of 42

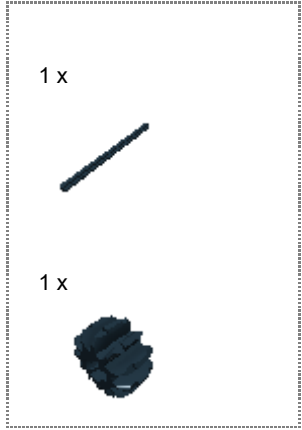

Step 26 of 42

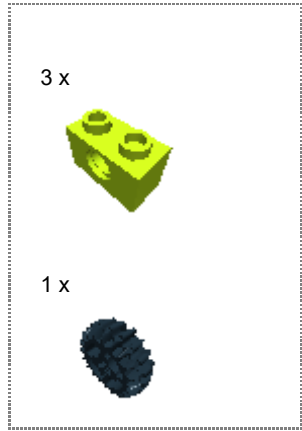

Step 27 of 42

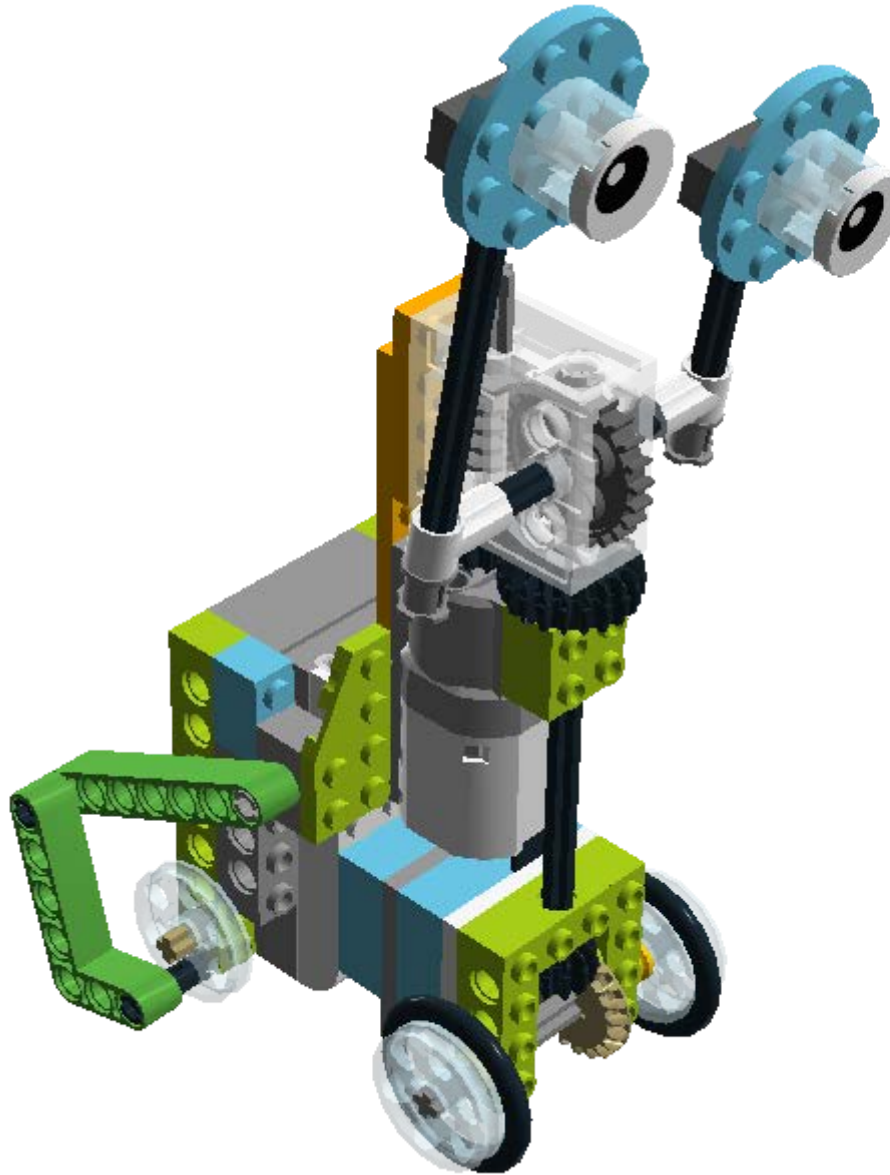

Step 28 of 42

1 x



2 x



1 x

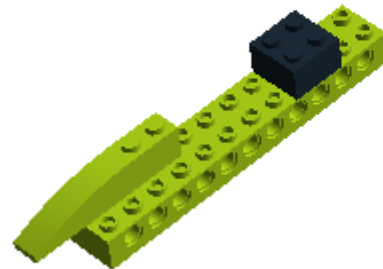

Step 29 of 42

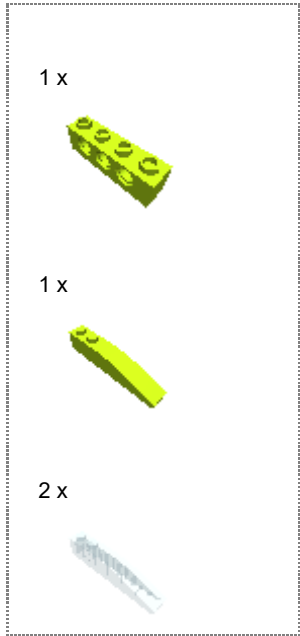

Step 30 of 42

1 x



1 x



2 x



Step 31 of 42

1 x



2 x



1 x

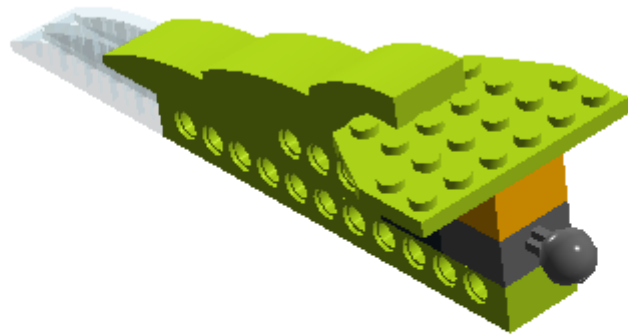



Step 32 of 42

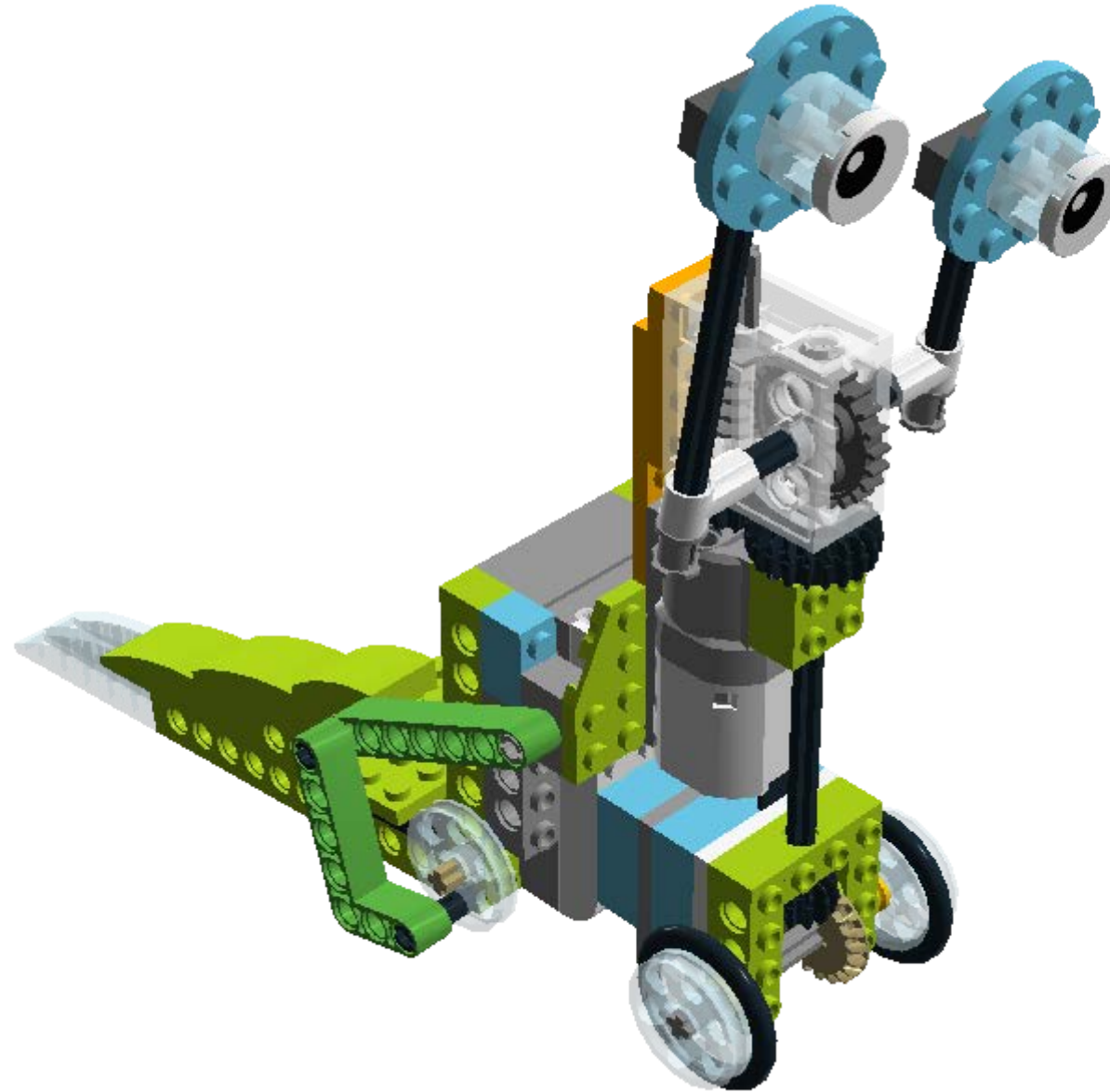

**Step 33 of 42**

1 x



**Step 34 of 42**

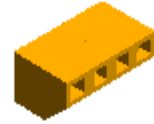
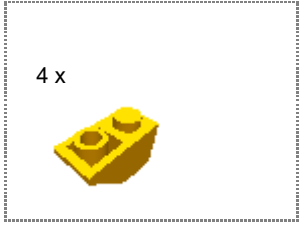

Step 35 of 42

1 x

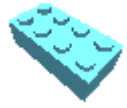

2 x



1 x

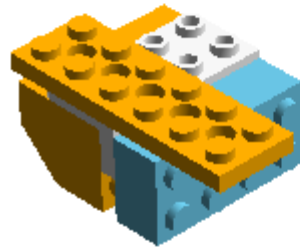

Step 36 of 42

1 x



2 x



1 x

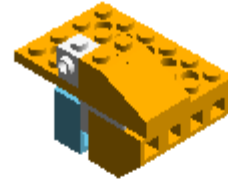

**Step 37 of 42**

1 x



1 x



2 x

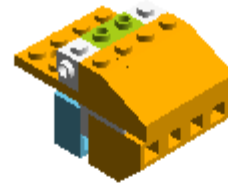

**Step 38 of 42**

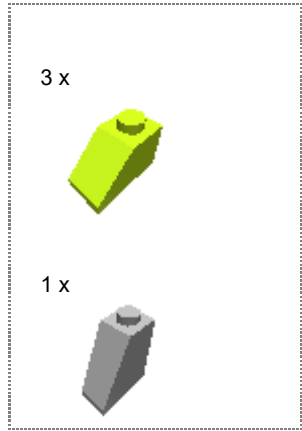

Step 39 of 42

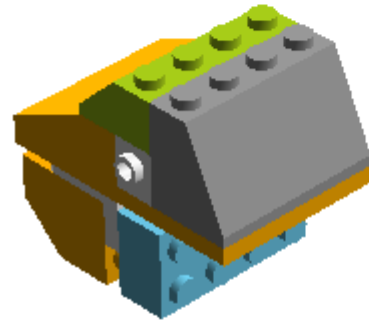
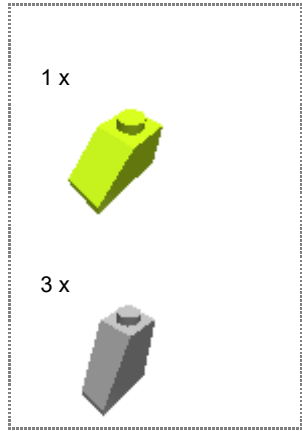



**Step 40 of 42**

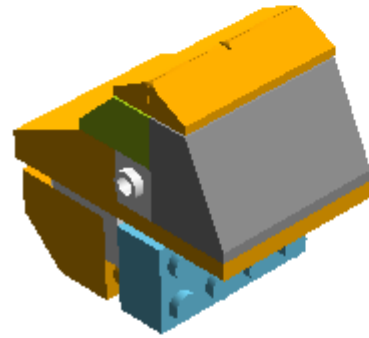
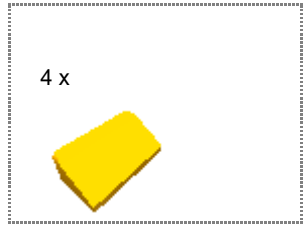



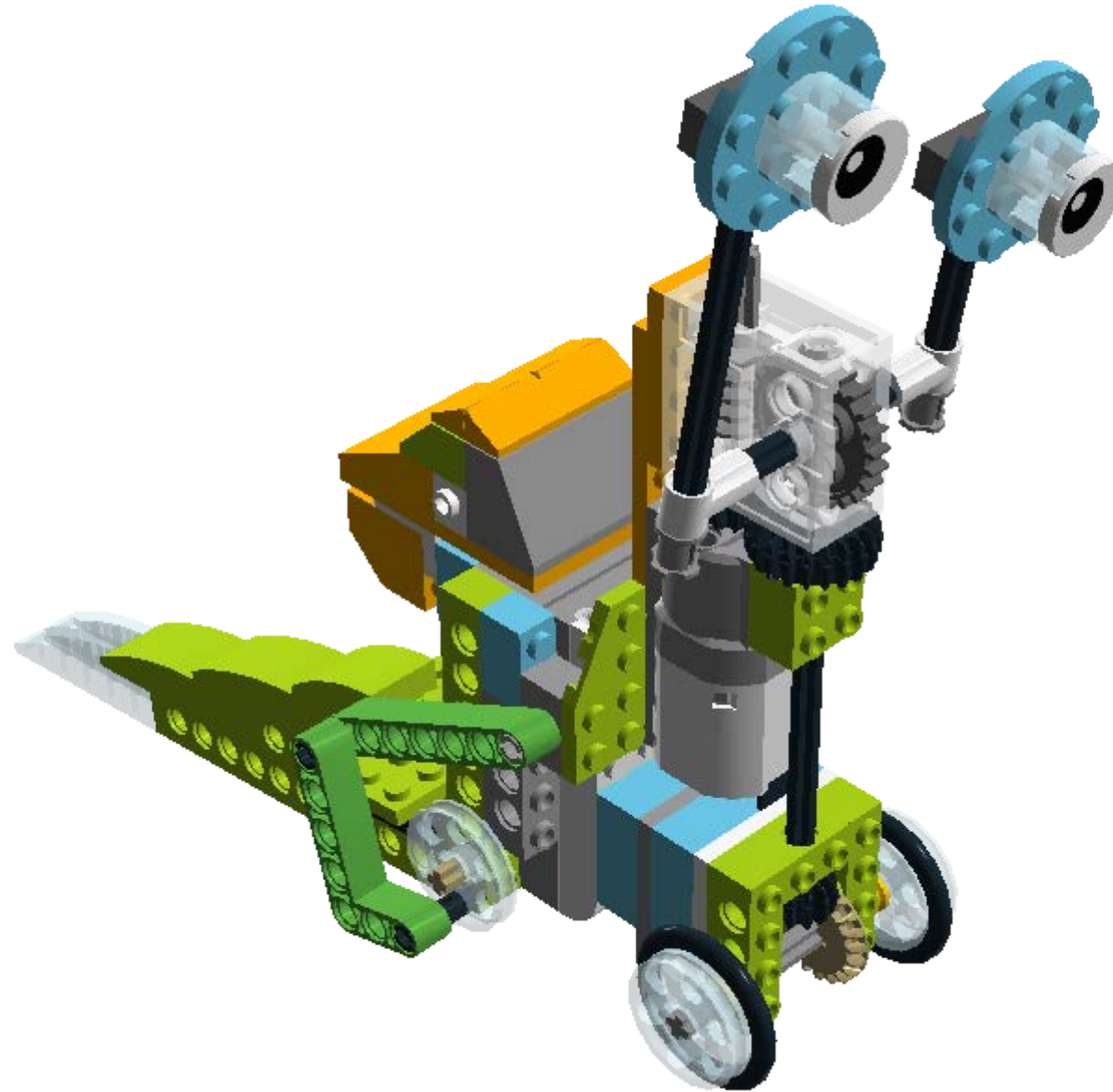

Step 41 of 42

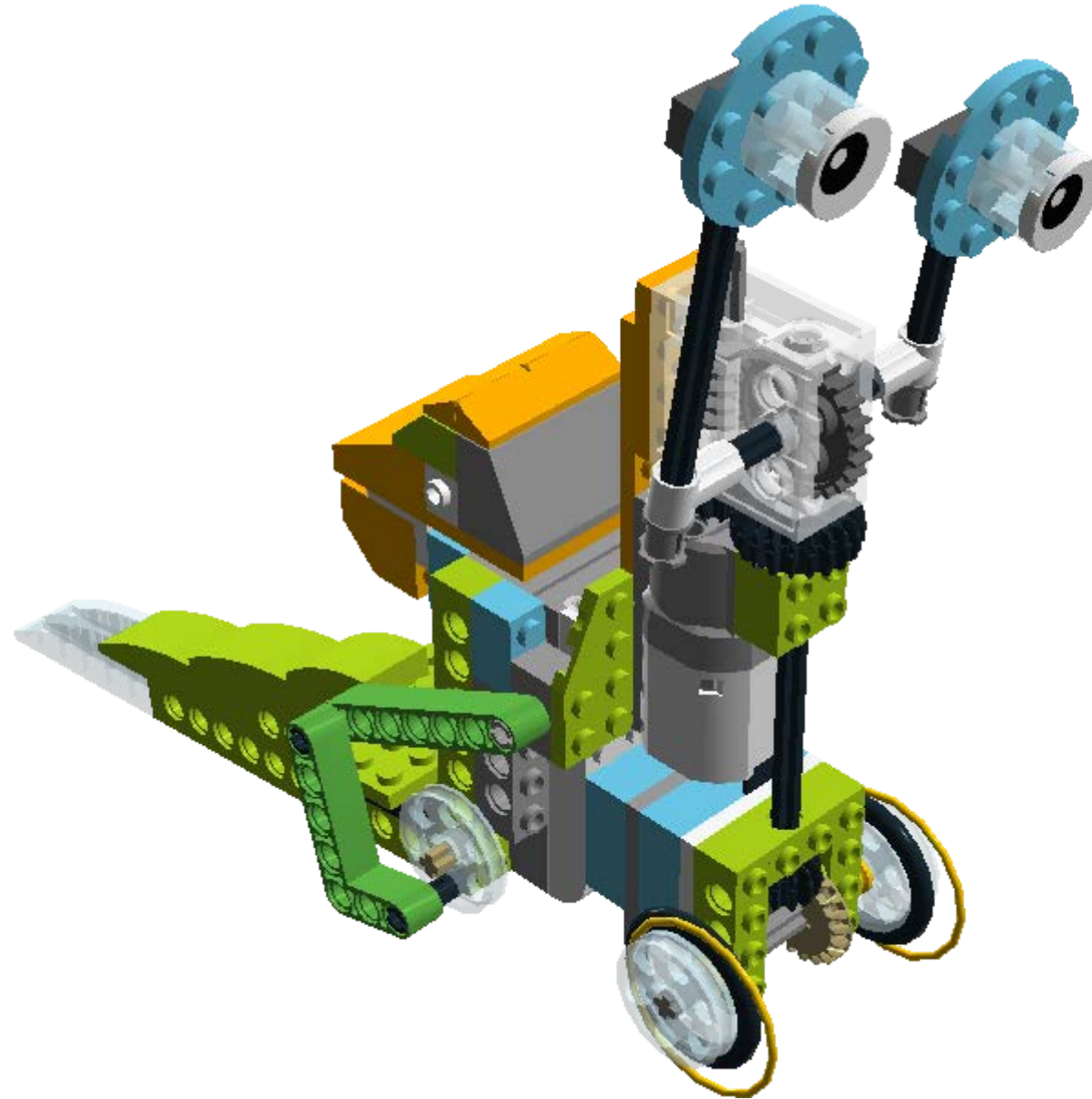

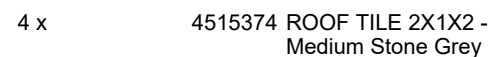
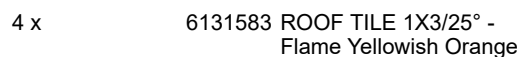
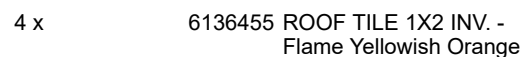
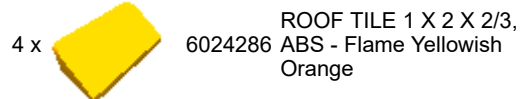
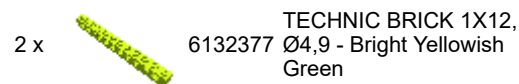
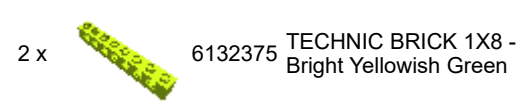
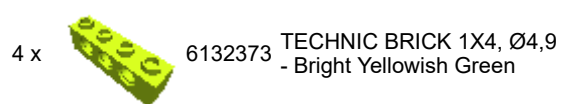
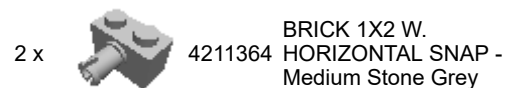
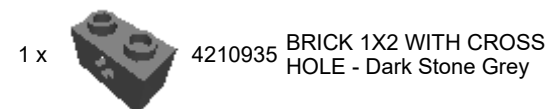
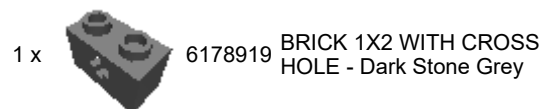
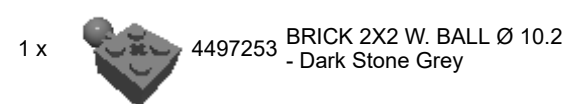
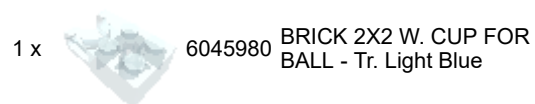
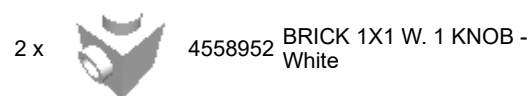
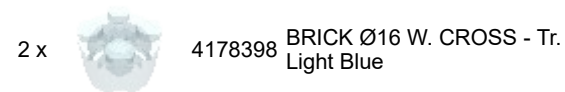
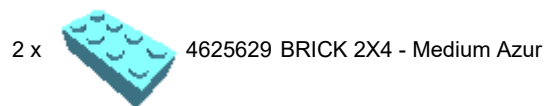
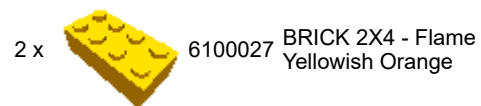
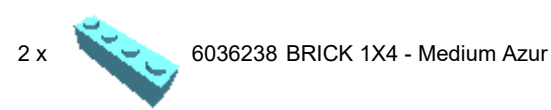
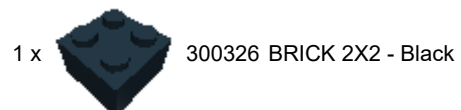
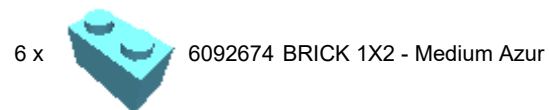
Step 42 of 42





								
2 x		4537928 BRICK W/BOW 1/3 - Bright Yellowish Green	4 x		6139693 BRICK 1X6 W/BOW - Bright Yellowish Green	2 x		6032418 BRICK 1X6 W/BOW - Tr. Light Blue
2 x		302301 PLATE 1X2 - White	1 x		371001 PLATE 1X4 - White	1 x		4612621 FRAME PLATE 4X4 - Medium Stone Grey
2 x		6060734 FLAT TILE 2X2, ROUND - White	2 x		6102828 PLATE 4X4 ROUND W. SNAP - Medium Azur	2 x		6116514 PLATE 4X6 26 DEGREES - Bright Yellowish Green
1 x		6132408 PLATE 2X4, 3XØ4.9 - Flame Yellowish Orange	2 x		6117940 ANGLE PLATE 1X2 / 2X2 - White	4 x		6132409 PLATE 2X6 W. HOLES - Flame Yellowish Orange
6 x		6096296 WEDGE-BELT WHEEL Ø24 - Tr. Light Blue	2 x		6028041 TYRE FOR WEDGE-BELT WHEEL - Black	2 x		LPF2.0 MEDIUM MOTOR - White, Bright Red, Black, Transparent, Medium Stone Grey
1 x		6181656 LPF2 SMART HUB 2 I/O 4X8X3 - White, Dark Green, Transparent, Medium Stone Grey	2 x		6097392 TECHNIC 7M BEAM - Bright Green	2 x		6097397 TECHNIC ANG. BEAM 3X5 90 DEG. - Bright Green

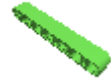
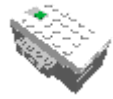

2 x



4239601 1/2 BUSH - Bright Yellow

4 x

4121715 CONNECTOR PEG W.  
FRICTION - Black

2 x

4666579 CONNECTOR PEG/CROSS  
AXLE - Brick Yellow

2 x

4211622 BUSH FOR CROSS AXLE -  
Medium Stone Grey

2 x

4118981 ANGLE ELEMENT, 0  
DEGREES [1] - White

2 x



370626 CROSS AXLE 6M - Black

2 x

4211805 CROSS AXLE 7M - Medium  
Stone Grey

2 x



373726 CROSS AXLE 10M - Black

2 x

4177431 DOUBLE CONICAL WHEEL  
Z12 1M - Black

1 x

4211510 WORM - Medium Stone  
Grey

1 x

6031962 BEVEL GEAR Z20 - Brick  
Yellow

1 x

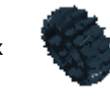
6093977 DOUBLE CONICAL WHEEL  
Z20 1M - Black

1 x

4514558 GEAR WHEEL Z24 - Dark  
Stone Grey

1 x

4142824 WORM GEAR BLOCK,  
TRANSP. - Transparent

2 x

4544151 V-BELT Ø33, YELLOW -  
Bright Yellow